

Final Investigation Report on Serious Incident of Runway Excursion to M/s Ambition Flying Club Cessna 172 R aircraft VT-AFR at Aligarh on 11.07.2021

1. Aircraft Type : Cessna 172 R
Nationality : Indian
Registration : VT-AFR
2. Owner/ Operator : M/s Ambition Flying Club Pvt. Ltd
3. Pilot-in-Command : CPL Holder (Instructor)
Extent of injuries : Nil
4. Co-Pilot : SPL Holder (Student Pilot)
Extent of injuries : Nil
5. Place of Incident : Aligarh Aerodrome
6. Geographical Location of Site : Latitude: 27°51'41''N
Longitude: 78°08'42'' E
7. Date & Time of Incident : 11.07.2021
1025 Hrs IST (Approx.)
8. Last point of Departure : Aligarh
9. Point of intended landing : Aligarh
10. Type of operation : Training flight
11. Person on Board : Two
12. Extent of injuries : Nil
13. Phase of operation : Landing
14. Type of incident : Runway Excursion

(All the timing in the report is in IST, otherwise mentioned)

SYNOPSIS

On 11.07.2021, M/s Ambition Flying Club Cessna 172 R aircraft VT-AFR while landing on runway 11 at 10:25 hrs IST(approx.) was involved in the incident of runway excursion at Aligarh Airport. The aircraft was performing a training flight (circuit and landing exercise) and was under the control of trainee pilot under supervision of flight instructor.

The aircraft completed two circuit and landing uneventfully and this was the third landing. Aircraft landed smoothly on runway 11, while the aircraft was on landing roll, the RH main landing gear collapsed and due to which the tail portion of the aircraft hit the runway and subsequently mooring eyebolt got broken. Subsequently the aircraft started drifting towards right from the centerline of the runway and went out of the runway. The aircraft travelled total 68 meters of distance from tail hit point and came to a halt in soft ground at 10 meters from the runway edge.

The student pilot and instructor came out of aircraft unhurt, however the aircraft sustained damages. There was no evidence of fire at any stage during the incident.

DGCA ordered the investigation into the cause of the incident by appointing an Investigator-In-Charge under Rule 13(1) of the Aircraft (Investigation of Accidents and Incidents) Rules, 2017.

The investigation revealed that the Right Main Landing Gear (RH-MLG) tubular strut has probably failed due to fatigue loads.

1. FACTUAL INFORMATION

1.1. HISTORY OF THE FLIGHT:

On 11.07.2021 M/s Ambition Flying Club aircraft Cessna 172R VT-AFR was scheduled for local flying at Aligarh Airport. The Maintenance Manager carried out Daily Inspection and aircraft was accepted by Flight Instructor (FI). The Flight Instructor authorized Assistant Flight Instructor (AFI) and student pilot for circuit and landing flight at 09:40hrs. The pre-flight checks were carried by student pilot under supervision of AFI and all were normal before the first flight. The trainee pilot underwent pre-flight breath-analyzer test and Instructor submitted BA undertaking in compliance to DGCA order no. DGCA-15031/4/2020-DAS dated 13.05.2021, before operating the flight.

The met briefing was taken by crew, the visibility was 5kms with little haize. The aircraft was cleared to taxi via Alpha and runway in use was runway 11. The aircraft took off around 09:52hrs. The aircraft took around 10 minutes for completing first circuit and landed back safely. The crew practiced 20° degree flap landing in first circuit. After landing the aircraft backtracked and took off for second circuit & landing. In second circuit & landing also the 20° degree flap landing was practiced. The aircraft completed two circuit & landing uneventfully and took off for third circuit.

As per the statement of Instructor and student pilot, in third landing the approach was normal and aircraft touched down smoothly on runway 11 at approx. 1200 feet from threshold and started rolling. The instructor instructed student pilot to let aircraft roll, then stop as per procedure and then request back track and line up for next circuit. While the aircraft was on landing roll and comparatively slowed down after rolling 700 feet approx. the crew realized that the aircraft was drifting to the right. The instructor confirmed from the student pilot whether he was applying right rudder or brake which the student denied. Just after few seconds the breaking sound was heard by the crew and the RH main landing gear got collapsed. The tail hit the runway and subsequently tail mooring eyebolt got broken and thereafter right horizontal stabilizer touched the runway surface and started rubbing. The instructor immediately cut the mixture and student pilot retracted the flaps and tried to apply brake. The aircraft kept drifting towards right and left runway near middle marker and went into the soft ground. The aircraft came to halt at 10 meters from

the runway edge. The aircraft travelled total 68 meters of distance from tail hit point .The crew switched off avionics, beacon and masters and came out of aircraft safely using left door.

Flight instructor was monitoring R/T communication from ground. As per his statement the aircraft was rolling normally after landing and suddenly he saw the aircraft veering towards right and went out of the runway. He immediately rushed to the site and by the time he reached the crew already came out of aircraft safely.

There was no fire as a result of the incident and no injury was reported to either of the occupants. However, the aircraft sustained damages. Post incident Instructor was also subjected to post flight breath-analyzer examination and result was negative.

1.2. INJURIES TO PERSON

INJURIES	CREW	PASSENGERS	OTHERS
FATAL	Nil	Nil	Nil
SERIOUS	Nil	Nil	Nil
MINOR/NONE	Nil/02	Nil	

1.3. DAMAGE TO AIRCRAFT

The aircraft sustained following damages:

1. RH main landing gear spring assembly was found broken between inbound bulkhead and outbound bulkhead (Figure: 1)
2. RH horizontal Stabilizer along with elevator was found bent at middle portion (Figure: 2)
3. Scratches were observed on bottom skin of RH elevator (Figure: 3)
4. Mooring eyebolt was found broken and detached from the aircraft (Figure: 4)



Fig:1



Fig:2



Fig-3



Fig:4

1.4. OTHER DAMAGE

NIL

1.5 PERSONNEL INFORMATION:

1.5.1. Pilot-in-Command (Instructor)

AGE	28 yrs
License	CPL (A)
Date of Issue	15.11.2018
Valid up to	14.11.2023
Category	Aeroplane
Date of Class I Med. Exam	28.06.2021
Class I Medical Valid up to	04.07.2022
AFIR rating Cessna 172 renewed on	01.08.2020
AFIR rating valid up to	31.07.2021
Date of issue FRTTO License	15.11.2018
FRTTO license valid up to	14.11.2023
Total flying experience	686:25
Total flying experience on the type	577:35
Total flying experience during last 1 year	349:00
Total flying experience during last 6 months	186:40
Total flying experience during last 90 days	72:20
Total flying experience during last 30 days	19:20
Total flying experience during last 7 days	06:45
Total flying experience during last 24 hours	00:35
Rest before the flight	No flying a day before

1.5.2. Co-pilot (Student Pilot)

AGE	29Yrs
License	SPL
Date of Issue	17.10.2020
Valid up to	16.10.2025
Category	Aeroplane
Date of Class I Med. Exam	09.11.2020
Class I Medical Valid up to	27.11.2021
Date of issue FRT0 License	02.11.2020
FRT0 license valid up to	01.11.2030
Total flying experience	73:20Hrs
Total Flying experience Dual	51:55Hrs
Total Flying experience Solo	21:25Hrs
Total flying experience during last 1 year	73:20Hrs
Total flying experience during last 6 months	70:15Hrs
Total flying experience during last 90 days	51:45Hrs
Total flying experience during last 30 days	19:20Hrs
Total flying experience during last 7 days	01:40Hrs
Total flying experience during last 24 hours	00:35Hrs
Rest before the flight	5 DAYS REST

1.6 AIRCRAFT INFORMATION:

1.6.1 **General Description:** The CESSNA 172R aircraft is a four-seater, fixed tricycle landing gear, general aviation airplane, used for flight training. Cessna 172R aircraft is powered with one Avco Lycoming, 4 cylinder, IO-360-L2A normally-aspirated, direct drive, air cooled, horizontally opposed, injector equipped engines using 100 LL fuel. The engine has a Horsepower rating of 160 BHP with engine speed of 2400 RPM. The aircraft is fitted with fixed pitch McCauley Propeller of model No.1C235/LFA7570 having two blades.

1.6.2 Aircraft Technical Information

Aircraft Model	Cessna 172R
Aircraft S. No.	MSN 17281084
Year of Manufacturer	2001
Certificate of Registration (C of R) No. and date of issue	3811/3 Category 'A', dated 16.02.2009
Certificate of Airworthiness (C of A) No.	5020/2
Airworthiness Review Certificate	DDG/NR/2021/89 valid upto 15.06.2022
Category	Normal
Sub Division	Passenger
Owner	M/s Ambition Flying Club Pvt Ltd
Minimum Crew Required	One
Maximum All Up Weight Authorised	1111.6Kg
Last Major Inspection	100hrs Inspection
Last Inspection	05.07.2021
Air frame Hrs. Since New	12686:55Hrs
Engine	
Manufacturer	Avco Lycoming
Type	Four Cylinder Piston Engine
Serial No.	L-33629-51E
Hours Done Since New	5627:35Hrs
TSO	1668:45hrs

Landing Gear System: The landing gear is of tricycle type, with a steerable nose wheel and two main wheels. Shock absorption is provided by the tubular spring steel main landing gear struts and the air/oil nose gear sock strut. Each main gear wheel is equipped with a hydraulically actuated disk type brake on the inbound side of each wheel.

Main wheel landing gear strut is fitted to the aircraft in inbound and outbound bulkhead for landing gear. The tubular strut is fitted to inbound bulkhead with bolt, nut and washer and to outbound bulkhead with bush and retainer.

Information on failed landing gear strut:

The landing gear strut which failed during the incident on 11.07.2021 was fitted on this aircraft on 27.07.2020. After fitment of this landing gear strut the aircraft carried out 2574 landings and 1426:35 hours flying till failure of strut. This strut was procured new from vendor when the earlier strut was found cracked during heavy/overweight inspection. The details are as follows:

On 07.07.2020 Pilot in command after operating training flight, reported that he noticed some noise from RH Main landing gear. The heavy/ overweight inspection was carried out by AME and in the inspection the tubular spring steel main landing gear struts was found cracked. The new landing gear strut was procured from vendor and same was replaced along with hardware and aircraft was released on 27.07.2020. After the replacement of new RH (MLG) on 27.07.2020, following inspections related to MLG spring strut were carried out till the incident on 11.07.2021:

- i. Inspection-II/100hrs schedule on 31.07.2020 wherein MLG assembly and axle were checked as per inspection schedule.
- ii. Inspection-V/400hrs and Inspection-IV/200hrs schedule carried out on 22.8.2020 wherein MLG assembly and axle were checked as per inspection schedule.
- iii. Inspection-II/100hrs inspection was carried out on 10.09.2020. During this RH main wheel axle and bearing was checked for proper fitment.
- iv. Inspection-IV/200hrs inspection carried out on 28.09.2020 wherein MLG assembly and axle were checked as per inspection schedule.

- v. Inspection-II/100hrs schedule on 18.10.2020 wherein MLG assembly and axle were checked as per inspection schedule.
- vi. Inspection-V/400hrs and Inspection-IV/200hrs schedule carried out on 17.11.2020. During this inspection RH main wheel tire was replaced with new, RH main wheel axle and bearing was checked for proper fitment.
- vii. Inspection operation 34 main landing gear fitting inspection and Inspection operation 37 Main landing gear axle inspection was carried out on 04.12.2020 wherein MLG assembly and axle were checked as per supplement inspection documents and found satisfactory.
- viii. Inspection-II/100hrs inspection was carried out on 16.12.2020.MLG assembly and axle was checked as per inspection schedule.
- ix. Inspection-IV/200hrs inspection carried out on 13.01.2021 wherein MLG assembly and axle were checked as per inspection schedule. Also the RH main wheel tire was replaced with new. During replacement of tire main wheel axle and bearing was checked for proper fitment.
- x. Inspection-II/100hrs inspection was carried out on 13.02.2021.MLG assembly and axle were checked as per inspection schedule.
- xi. Inspection-V/400hrs and Inspection-IV/200hrs schedule carried out on 09.03.2021. During this inspection MLG assembly and axle were checked as per inspection schedule.
- xii. Inspection-II/100hrs inspection was carried out on 02.04.2021.During this inspection RH main wheel tire was replaced .RH MLG assembly and RH main wheel axle and bearing was checked for proper fitment.
- xiii. Inspection-IV/200hrs inspection carried out on 21.04.2021 wherein MLG assembly and axle were checked as per inspection schedule.
- xiv. Inspection-II/100hrs schedule was carried out on 15.05.2021.MLG assembly and axle as per inspection schedule was checked.
- xv. During Daily inspection carried out on aircraft on 28.05.2021, RH main wheel tire was replaced with new. During replacement of tire axle and bearing was checked.

- xvi. Inspection-V/400hrs and Inspection-IV/200hrs schedule carried out on 14.06.2021. During this inspection MLG assembly and axle were checked as per inspection schedule.
- xvii. The 100hrs inspection of aircraft was carried on 05.07.2021 wherein the main landing gear assembly attachment structure were checked for damage, cracks, loose rivets, bolt and nuts, security of attachment. Also main landing gear strut fairing and cuff were checked for cracks, dents.

1.7 METEOROLOGICAL INFORMATION:

There is no Meteorological office located at Aligarh from where weather observations are taken and recorded. Ambitions Flying Club obtain Met Report from Air Force Station Agra, Bareilly & Delhi telephonically and from IMD/Windy and other sites which is available. Local METAR is obtained through local check points.

The local weather on 11.07.2021 was as follows:

At 110400Z Wind- 100/06Kt Visibility -5000HZ, Temp/Dew-33/26, QNH-1002, No Sig.

At 110600Z Wind-100/08Kt, Visibility -6000HZ, BKN 100 Temp/Dew-37/26, QNH-1004

1.8 AIDS TO NAVIGATION: Aligarh VOR is located 2.3 NM to the South East of the airfield.

1.9 COMMUNICATIONS:

During circuit flying on 11.07.2021, student pilot was in two-way communication with ground on R/T being manned by flight instructor at M/s Ambition Flying Club. However, no recording facility was available.

Ambitions Flying Club is allotted with 122.15 Mhz frequency and Air traffic is monitored by any instructor available on ground or senior student pilot holding valid RTR (A) license on VHF handset.

1.10 AERODROME INFORMATION:

Aligarh aerodrome is an uncontrolled aerodrome. The airstrip is located 2.3m North West of Aligarh VOR. It is 110°, 4.6 nm from Aligarh railway station. The runway orientation is 29/11. Runway Length (Approx. 4000 Feet). Wind sock is visible clearly visible from both the ends of runway.

1.11 FLIGHT RECORDERS:

Cockpit Voice Recorder (CVR) and Digital Flight Data Recorder (DFDR) were neither fitted nor required on this aircraft as per Civil Aviation Requirements.

1.12 WRECKAGE AND IMPACT INFORMATION:

The aircraft veered out the runway near middle marker and stopped in soft ground at a distance of 10 metres from the runway edge. No part / except mooring eyebolt of aircraft detached from aircraft. The eyebolt detached on runway and distance between aircraft stoppage point and eyebolt detachment point is approx. 68 meters.

1.13 MEDICAL AND PATHOLOGICAL INFORMATION:

The student pilot had undergone pre-flight breath-analyzer test and Instructor submitted BA undertaking before operating flight. Post incident Instructor was also subjected to post flight breath-analyzer examination and result was negative.

1.14 FIRE:

There was no pre/post incident fire.

1.15 SURVIVAL ASPECTS:

The incident was survivable.

1.16 TESTS AND RESEARCH:

Following test and research were carried out:

1.16.1. Test of fuel and oil sample taken from the aircraft:

Fuel and oil samples were sent to DGCA lab for examination. The fuel sample passed all tests. However the oil sample failed as the viscosity of oil sample at 100°C was 18.7 which does not fall in the required range of 21.9-26.1 for the specification no. SAE J1899 GR 60.

1.16.2. Laboratory investigation of failed RH-MLG Tubular Strut: The failed RH-MLG's tubular strut along with airframe attachment bolt, nut, bushing, wheel & brake assembly and inboard bulkhead were forwarded to AED lab Laboratory Examination. These failed parts have been examined by lab visually and using stereo-microscope (up to 50X). The observations are as follows:-

- i. The horizontal portion of the tubular strut which is bolted and supported at the inboard and outboard landing gear bulkheads respectively is found fractured and disintegrated between its inboard bolt hole end and outboard bushing interface end as shown in Fig 5 & 6.

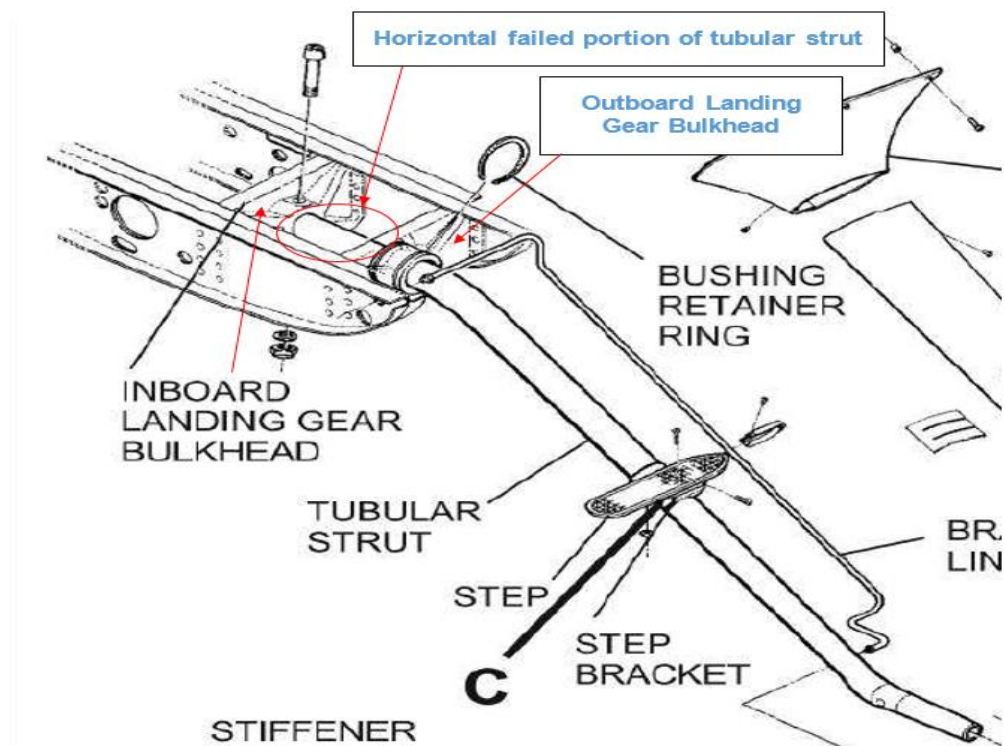

Failed horizontal portion of the tubular strut as seen in illustrated parts catalogue

Fig-5



Fig 6

- ii. The bolt, nut and bushing are found to be in satisfactory condition except some damages on the threaded portion of the bolt as shown in Fig. 7



Thread damage on the bolt fastening at inboard landing gear bulkhead

Fig-7

- iii. The outer diameter of the wheel axle at the wheel bearing locations dimensionally found to be undersized and worn out from prescribed limits.



Bearing locations on the wheel axle

Fig-8

- iv. The rollers within tapered bearing units are found to have corrosion pitting and brinelling marks.

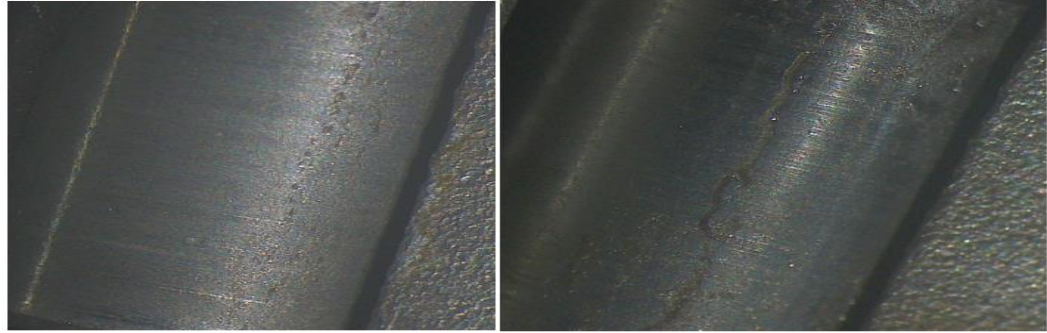

Corrosion pitting and brinelling marks on the rollers of bearing

Fig-9

v. The inbound landing gear Bulkhead (IB-LGB's) bore diameter and its bolt holes diameter were dimensionally checked and they are found to be oversized beyond the prescribed limits.

vi. It is evident from the macroscopic examination of the failed tubular strut that the crack initiation point was at the top bolt hole region and crack has propagated under fatigue loads. The availability of beach marks & their direction at lower magnification (16X) and faint striation mark at higher magnification (624X) confirms that the crack initiation point was at the top bolt hole region and crack has propagated under fatigue loads.

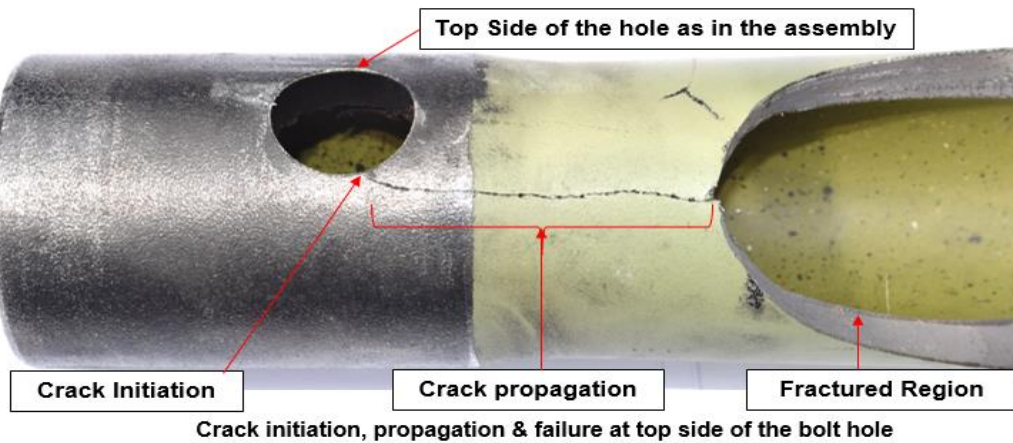
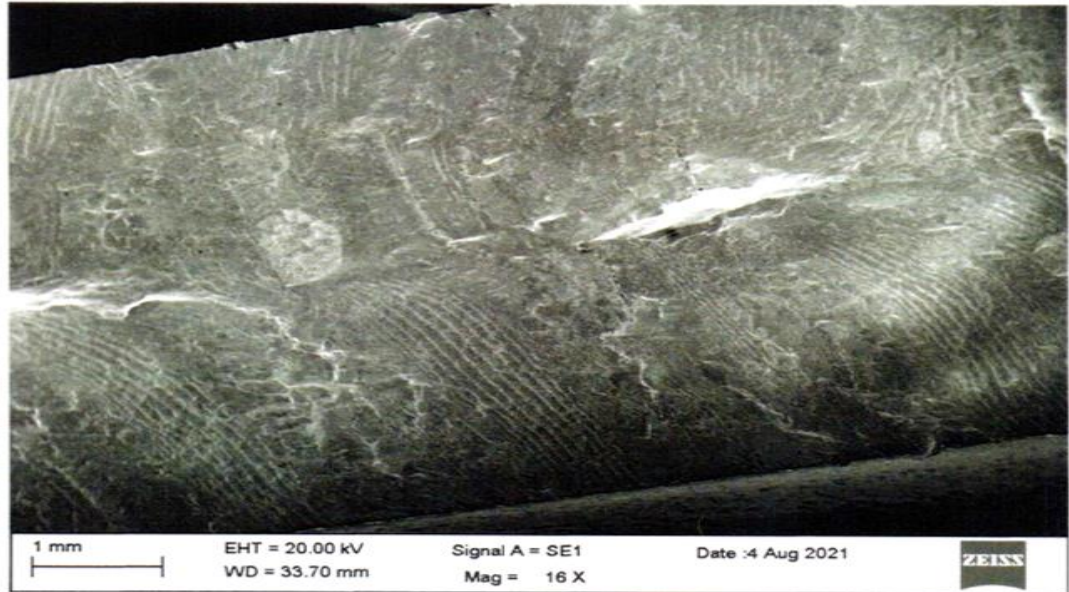
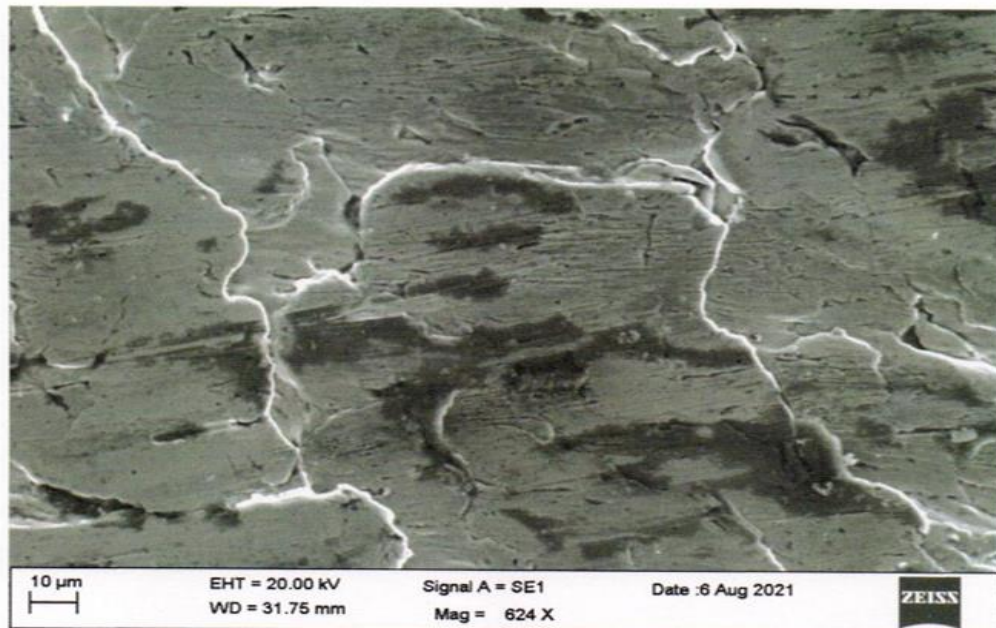

Fig-10(a)



Cyclic loading pattern seen on the crack propagation region in SEM

Fig-10(b)



Striation marks seen on the crack propagation region in SEM

Fig-10(c)

The fatigue cracking would have propagated over certain length, causing structural discontinuity in the strut and eventually disintegrating the tubular strut under rapid overload which is evident from the slant, fibrous and dimple features observed on fracture surfaces of failed strut's fragmented portions.



Slant, fibrous feature and chevron marks seen on the fracture surface

Fig-11(a)

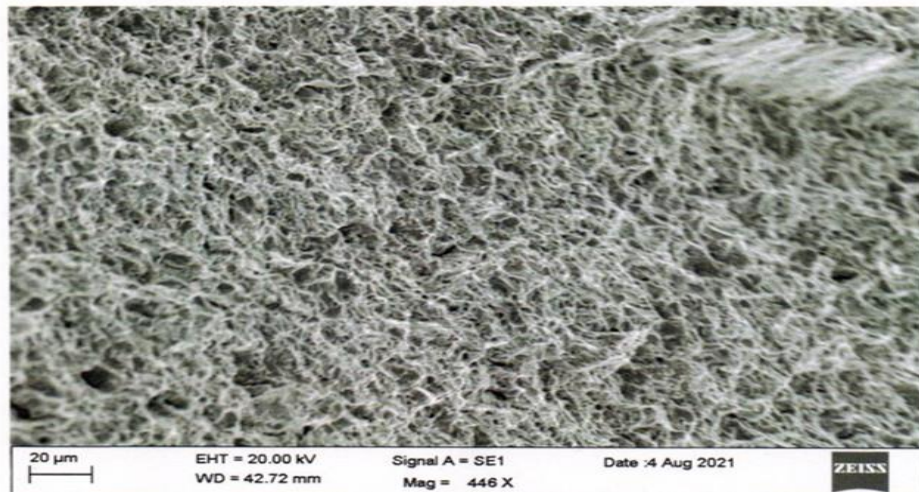

Dimple signature seen on the disintegrated fracture portion of the strut under SEM

Fig-11(b)

- vii. The availability of semicircular arc impression observed around the bottom bolt hole region of the tubular strut indicates that when the tubular strut was installed into the bore of the IB-LGB with the bolt & nut, probably the recess damage region on the IB-LGB had not come in contact with the tubular strut and only the surfaces outside the recess region had come in contact with

strut which confirms that the recess damage was probably pre-existing in the IB-LGB bore.

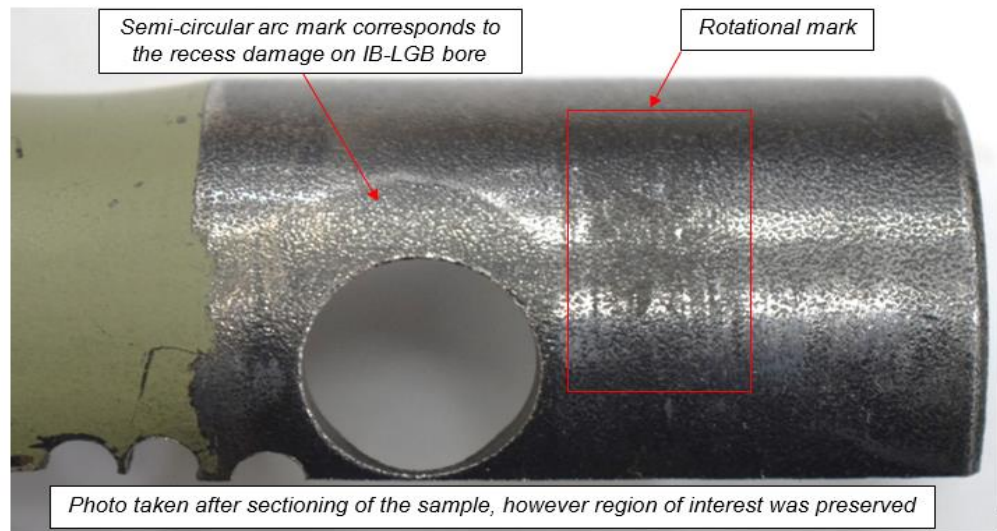

Circular arc and rotation mark at the tubular strut bottom bolt hole region

Fig-12

- viii. Also, the reduction in IB-LBG's bottom bolt hole grip impression on bolt shank and oversizing of the IB-LBG's bore diameter and its bolt holes diameter from dimension checks indicates that bottom bolt hole damage, bore and bolt holes oversizing were pre-existing.

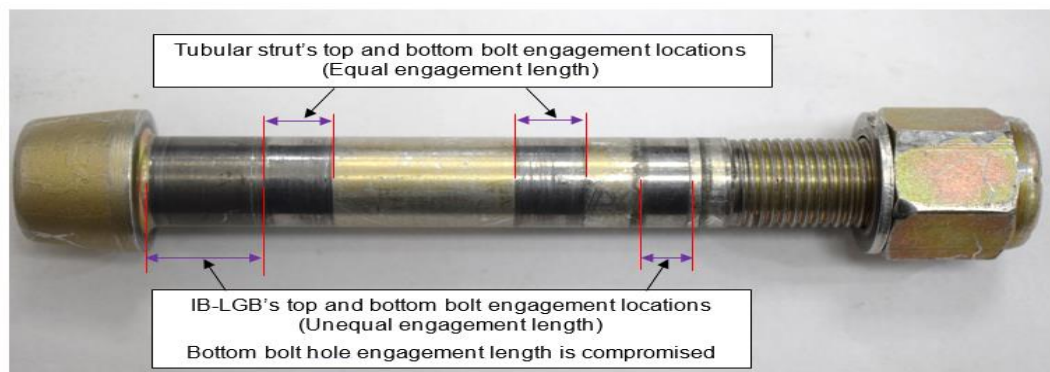

Unequal bolt engagement length from top and bottom bolt holes of IB-LGB

Fig-13

- ix. Further, the rotational marks on the bottom surface of the tubular strut indicates that due to the pre-existing recess damage and oversizing of the bore and bolt holes in the IB-LGB, probably the tubular strut would have undergone swinging motion within the bore region. The loads imposed at the

joint due to the probable swinging motion of strut in addition to the normal landing loads would have caused the strut to fail in over fatigue loads.

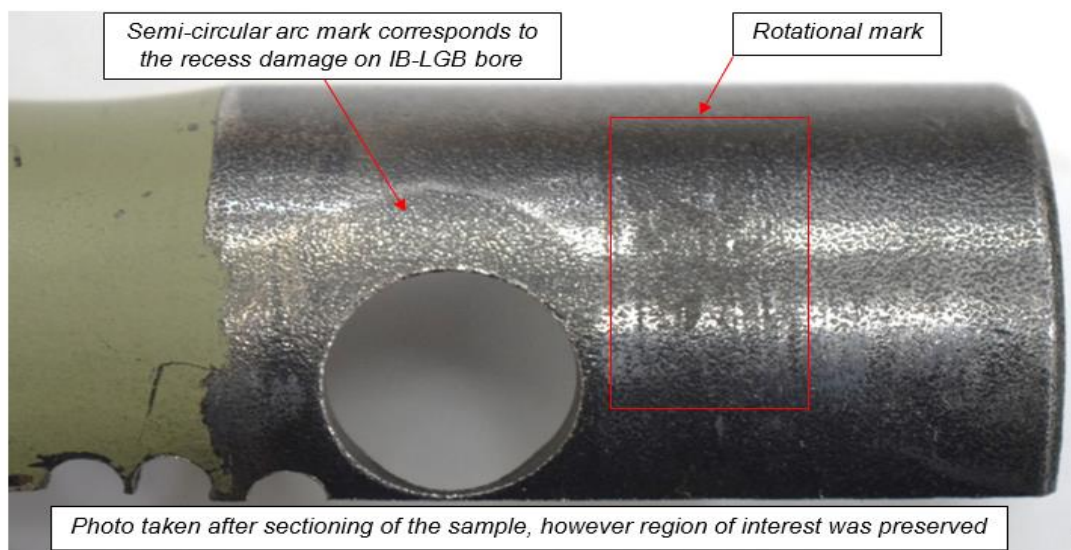

Circular arc and rotation mark at the tubular strut bottom bolt hole region

Fig-14

- x. The undersized wheel axle at bearing locations and deterioration of rollers in the bearing unit would not have any direct contribution to the fatigue failure.
- xi. The brake disc and brake pad/lining are found to be in satisfactory condition, their thickness dimension are checked and found to be within the prescribed limits.
- xii. There are no abnormal rubbing marks found on the wheel tire. The wheel rim units are also found to be in satisfactory condition.

1.17 ORGANIZATIONAL AND MANAGEMENT INFORMATION:

M/s Ambitions Flying Club is a Flying Training Organization approved by the Directorate General of Civil Aviation (DGCA), and having a fleet of 05 aircrafts. The fleet contains two Cessna 152, one piper Seneca-IV, one Cessna 172S and one Cessna 172R aircraft for flying training activities.

1.18 ADDITIONAL INFORMATION:

Quality Manager of M/s Ambitions Flying Club had shared details of incident with manufacturer and sought details of such incidents worldwide and probable cause of failure of tubular landing gear strut. The manufacturer replied that they did not have history of such issues related with the landing gear. However, they opined that it could be by pitting from corrosion of the gear or a crack in the gear due to hard landings of the aircraft.

1.19 USEFUL OR EFFECTIVE INVESTIGATION TECHNIQUES.

Nil.

2. ANALYSIS:

2.1 Operational Aspect:

On 11.07.2021 M/s Ambition Flying Club aircraft Cessna 172R was scheduled for local training flying at Aligarh. The maintenance manager carried out daily inspection (DI) and aircraft was accepted by FI. The FI authorized AFI and student for circuit & landing flight at 09:40hrs. The pre-flight checks were carried by student pilot under supervision of AFI and all were normal. The met briefing was taken by crew, the visibility was 5kms with little haze. This was the first sortie of the day.

The aircraft was cleared to taxi via Alpha and runway in use was runway 11. The aircraft took off around 09:52hrs. The aircraft took around 10 minutes for completing first circuit and landed back safely. The crew practiced 20 degree flap landing. After landing the aircraft was backtracked and took off for second circuit and landing. In second circuit and landing also the 20 degree flap landing was practiced. The aircraft completed two circuit & landing uneventfully and took off for third circuit.

As per the statement of Instructor and student pilot, aircraft touched down smoothly on runway 11 at approx. 1200 feet from threshold. While the aircraft was on landing roll and comparatively slowed down after rolling 700 feet approx the crew realized that the aircraft was drifting right from the centreline of runway. The instructor confirmed from the student pilot whether he was applying right rudder which the

student denied. The breaking sound was heard by the crew and the RH main landing gear collapsed. The crew cut the mixture and retracted the flaps. The aircraft started drifting towards right near middle marker and finally left the runway and went into soft ground. Aircraft after further travelling a distance approx. 68 meter came to a halt at 10 meters from the runway edge. The crew switched off avionics, beacon and masters and came out of aircraft safely using left door.

Flight instructor who was controlling the aircraft on R/T, stated that he gave clearance for taxi at approx 0950hrs and he was observing from ground. The line-up, take off, climb and circuit pattern were normal. Their approach and flare were proper and landing were normal. When they were approaching for third landing at approx. 10:25hrs their approach and landing was normal. After landing aircraft was rolling normally and suddenly he saw that aircraft started veering towards right of the runway and went into the soft ground.

From the statements of student pilot, on-board Instructor and Flight Instructor on ground monitoring R/T & aircraft flying, it appears that crew action were not the contributory factor for the incident. As aircraft is not fitted with any CVR/DFDR the statements of crew have been relied upon for conclusion.

2.2 Engineering Aspect:

The aircraft VT-AFR was having valid certificate of registration certificate of Airworthiness and Airworthiness review certificate on the day of operating the incident flight. On 11.07.2021 the daily inspection was carried out by maintenance manager and aircraft was released as serviceable. The aircraft was accepted by Flight Instructor.

The laboratory investigation of fuel sample passed all tests. However the oil sample failed, as the viscosity of oil sample at 100°C was 18.7 which does not fall in the required range of 21.9-26.1 for the specification no. SAE J1899 GR 60. However this is not the contributory factor for incident as SAE J1899 GR 50 oil can also be used in this aircraft and the viscosity of sample is within the range of SAE J1899 GR 50 and SAE J1899 GR 60. It appears that top up with SAE J1899 GR 60 oil was done without completely flushing out the system.

The failed parts had been examined at DGCA Laboratory and the lab investigation revealed that:

- i. The outer diameter of the wheel axle at the wheel bearing locations dimensionally found to be undersized and worn out from prescribed limits.
- ii. The rollers within tapered bearing units found to have corrosion pitting and brinelling marks.
- iii. The inbound landing gear Bulkhead (IB-LGB's) bore diameter and its bolt holes diameter were dimensionally found to be oversized beyond the prescribed limits.

The 100hrs inspection of aircraft was carried on 05.07.2021 wherein the main landing gear assembly attachment structure were checked for damage, cracks, loose rivets, bolt and nuts, security of attachment. Also main landing gear strut fairing and cuff were checked for cracks, dents. However, the crack in the RH MLG tubular strut which initiated from hole due fatigue load, was not detected in the visual inspection.

The Main landing gear tubular strut is fitted to IB-LGB with bolt & nut and with outbound bulkhead with bush and retainer. The inspection panel is located in between the inbound bulkhead and out bound bulkhead. If a crack is initiated from bolt hole it will remain undetected in visual inspection till it is propagated further and crosses the boundary of inbound bulkhead.

As per inspection schedule, all inspections on main landing gear tubular strut are visual.

After fitment of this landing gear strut the aircraft carried out 2574 landings and 1426:35 hours flying till failure of strut on the date of incident. After the last 100hrs inspection the aircraft had carried out total 73 landings and flown 42:15 hours only till incident on 11.07.2021.

The rotational marks on the bottom surface of the tubular strut indicates that due to the pre-existing recess damage and oversizing of the bore and bolt holes in the IB-LGB, probably the tubular strut would have undergone swinging motion within

the bore region. The loads imposed at the joint due to the probable swinging motion of strut in addition to the normal landing loads would have caused the strut to fail in over fatigue loads. Fatigue is the initiation and propagation of cracks in the material due to cyclic loading. Once a fatigue crack has initiated, it grows a small amount with each loading cycle, typically producing striations on some part of fracture surface.

It is evident from the above that the fatigue crack initiated at the top bolt hole and propagated over certain length, causing structural discontinuity in the strut and eventually disintegrating the tubular strut under rapid overload. Thus the RH-MLG tubular strut has probably failed due to fatigue loads.

3. CONCLUSIONS:

3.1. FINDINGS:

1. At the time of incident the aircraft was having valid certificate of registration certificate of Airworthiness and Airworthiness review certificate.
2. On 11.07.2021 the daily inspection was carried out by Maintenance Manager and aircraft was released as serviceable.
3. The Crew license were valid on the date of incident.
4. The RH landing gear strut was fitted on aircraft on 27.07.2020. This strut was procured new from vendor when the earlier strut was found cracked during heavy/overweight inspection on 07.07.2020.
5. After fitment of this landing gear strut the aircraft carried out 2574 landings and 1426:35 hours flying till failure of strut.
6. The 100hrs inspection of aircraft was carried on 05.07.2021 wherein the main landing gear assembly attachment structure were checked for damage, cracks, loose rivets, bolt and nuts, security of attachment. Also main landing gear strut fairing and cuff were checked for cracks, dents.
7. The fuel sample passed all tests. However the oil sample (SAE J1899 GR 60) failed for test of viscosity of oil sample at 100°C. However this is not the contributory factor for incident.
8. In this incident, there was no issue related to functioning/serviceability of engine.

9. The outer diameter of the wheel axle at the wheel bearing locations dimensionally found to be undersized and worn out from prescribed limits.
10. The rollers within tapered bearing units are found to have corrosion pitting and brinelling marks.
11. The inbound landing gear Bulkhead (IB-LGB's) bore diameter and its bolt holes diameter were found to be oversized beyond the prescribed limits.
12. The crack initiation point was at the top bolt hole region and crack has propagated under fatigue loads causing structural discontinuity in the strut and eventually disintegrating the tubular strut under rapid overload.
13. When the tubular strut was installed into the bore of the IB-LGB with the bolt & nut, the recess damage was probably pre-existing in the IB-LGB bore.
14. The reduction in IB-LGB's bottom bolt hole grip impression on bolt shank and oversizing of the IB-LGB's bore diameter and its bolt holes diameter from dimension checks indicates that bottom bolt hole damage, bore and bolt holes oversizing were pre-existing.
15. The loads imposed at the joint due to the probable swinging motion of strut in addition to the normal landing loads would have caused the strut to fail in over fatigue loads.
16. As per inspection schedules all inspections on landing gear strut are visual through inspection panel, located between inboard and outboard landing gear bulkheads. No crack was observed in 100hrs inspection schedule carried out on 05.07.2021.
17. The student pilot had undergone pre-flight breath-analyzer test and result was negative.
18. The Instructor submitted BA undertaking before operating the flight. Post incident Instructor was also subjected to post flight breath-analyzer examination after incident and result was negative.

3.2 PROBABLE CAUSES:

The fatigue crack initiated at the top bolt hole and propagated over certain length, causing structural discontinuity in the strut and eventually disintegrating the RH-MLG tubular strut under rapid overload.

4. SAFETY RECOMMENDATIONS:

- One time removal and inspection of LH-MLG tubular strut of aircraft VT-AFR for any crack/corrosion.
- One time dimension check of IB-LGB bore of left MLG for any oversizing to prevent any reoccurrence.



(SUKH PAL SINGH)
Assistant Director Air Safety
Investigator-In-Charge/VT-AFR

Place: New Delhi

Dated: 21.02.2023